

Round timber storage box 4

41 Litice

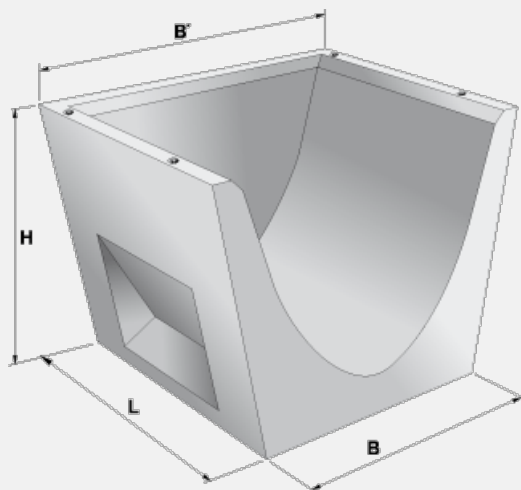

Trademark	Dimensions (cm)				Concrete Class	Volume (m3)	Weight (kg)
	L	B	H	B_1			
YZP 013-19	100	218	230	304,3	C 35/45 - XF1	2,3400	5850

Usage:

The round timber storage boxes serve for storage and manipulation with wood round timber in woodworking industry.