

Across Inlet socket reinforced-concrete pipe DN 800

07 Čerčany

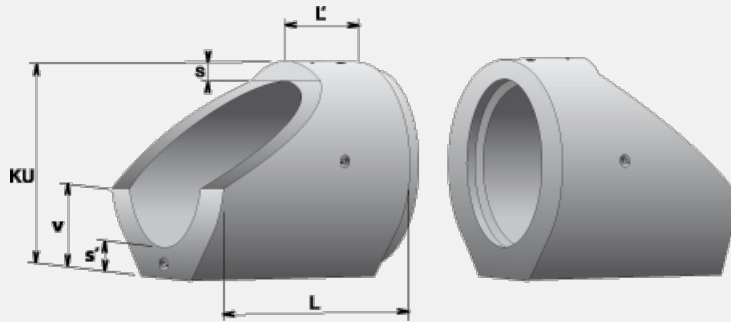

Trademark	Dimensions (cm)							Concrete Class	Volume (m3)	Weight (kg)
	L	T	D	L_1	H_2	D_1	T_1			
TZP 024-19	150	17	80	75	49	116	19	C 50/60-XF4	0,6492	1 591

Usage:

They are intended for the slant termination of tube culverts at inflow and outflow side, mounted from iron-concrete footer tubes under trackbed or road bed. Handling is made through transport fixtures with a ball. Outflow slant tubes are equipped with an integrated rubber seal at the socket. They are equipped with an earthing output against the effects of stray current.